

HSMS-2820

RF mixer/detector diode

Description



Lifecycle status: **Active**



Features

The HSMS-282x family of schottky diodes are the best all-round choice for most applications. These products featuring low series resistance, low forward voltage at all current levels, and good RF characteristics. Applications include clamping, low frequency mixers, biased detectors, and large signal zero bias detectors. VBR=15 V, Ct=1.0pF, RD=10 Ohms, Vf @ 1 mA=340 mV

Data Sheet

Description/Applications

These Schottky diodes are specifically designed for both analog and digital applications. This series offers a wide range of specifications and package configurations to give the designer wide flexibility. Typical applications of these Schottky diodes are mixing, detecting, switching, sampling, clamping, and wave shaping. The HSMS-282x series of diodes is the best all-around choice for most applications, featuring low series resistance, low forward voltage at all current levels and good RF characteristics.

Note that Avago's manufacturing techniques assure that dice found in pairs and quads are taken from adjacent sites on the wafer, assuring the highest degree of match.

Package Lead Code Identification, SOT-23/SOT-143 (Top View)

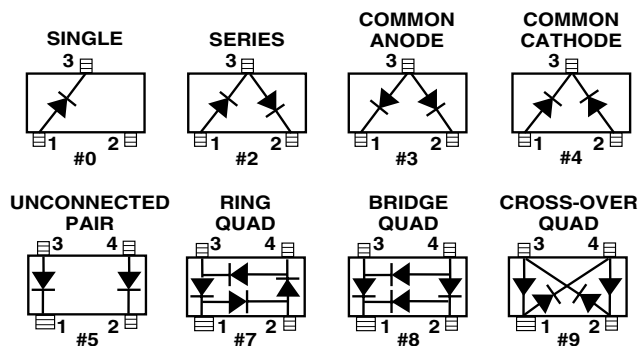

Package Lead Code Identification, SOT-323 (Top View)

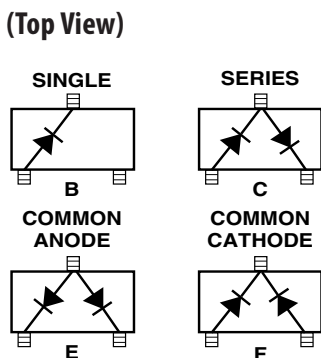

Features

- Low Turn-On Voltage (As Low as 0.34 V at 1 mA)
- Low FIT (Failure in Time) Rate*
- Six-sigma Quality Level
- Single, Dual and Quad Versions
- Unique Configurations in Surface Mount SOT-363 Package
 - increase flexibility
 - save board space
 - reduce cost
- HSMS-282K Grounded Center Leads Provide up to 10 dB Higher Isolation
- Matched Diodes for Consistent Performance
- Better Thermal Conductivity for Higher Power Dissipation
- Lead-free Option Available
- For more information see the Surface Mount Schottky Reliability Data Sheet.

Package Lead Code Identification, SOT-363 (Top View)

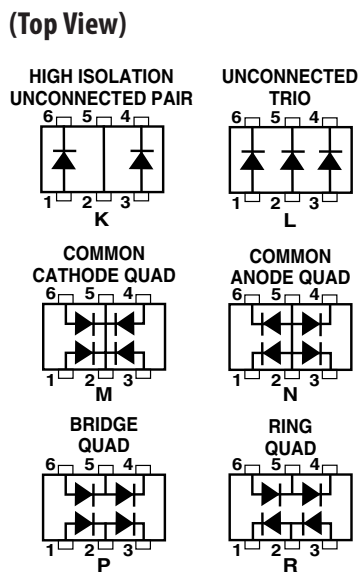

Pin Connections and Package Marking

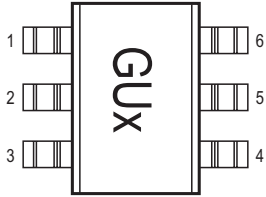

Notes:

1. Package marking provides orientation and identification.
2. See "Electrical Specifications" for appropriate package marking.

Absolute Maximum Ratings^[1] $T_c = 25^\circ\text{C}$

Symbol	Parameter	Unit	SOT-23/SOT-143	SOT-323/SOT-363
I_f	Forward Current (1 μs Pulse)	Amp	1	1
P_{IV}	Peak Inverse Voltage	V	15	15
T_j	Junction Temperature	$^\circ\text{C}$	150	150
T_{stg}	Storage Temperature	$^\circ\text{C}$	-65 to 150	-65 to 150
θ_{jc}	Thermal Resistance ^[2]	$^\circ\text{C}/\text{W}$	500	150

Notes:

1. Operation in excess of any one of these conditions may result in permanent damage to the device.
2. $T_c = +25^\circ\text{C}$, where T_c is defined to be the temperature at the package pins where contact is made to the circuit board.

Electrical Specifications $T_c = 25^\circ\text{C}$, Single Diode^[3]

Part Number HSMS ^[4]	Package Marking Code	Lead Code	Configuration	Minimum Breakdown Voltage V_{BR} (V)	Maximum Forward Voltage V_F (mV)	Maximum Forward Voltage V_F (V) @ I_F (mA)	Maximum Reverse Leakage I_R (nA) @ V_R (V)	Maximum Capacitance C_T (pF)	Typical Dynamic Resistance R_D (Ω) ^[5]						
2820	C0	0	Single	15	340	0.5 10	100 1	1.0	12						
2822	C2	2	Series												
2823	C3	3	Common Anode												
2824	C4	4	Common Cathode												
2825	C5	5	Unconnected Pair												
2827	C7	7	Ring Quad ^[4]												
2828	C8	8	Bridge Quad ^[4]												
2829	C9	9	Cross-over Quad												
282B	C0	B	Single												
282C	C2	C	Series												
282E	C3	E	Common Anode												
282F	C4	F	Common Cathode												
282K	CK	K	High Isolation Unconnected Pair												
282L	CL	L	Unconnected Trio												
282M	HH	M	Common Cathode Quad												
282N	NN	N	Common Anode Quad												
282P	CP	P	Bridge Quad												
282R	OO	R	Ring Quad												
Test Conditions										$I_R = 100 \mu\text{A}$	$I_F = 1 \text{ mA}^{[1]}$			$V_R = 0\text{V}^{[2]}$ $f = 1 \text{ MHz}$	$I_F = 5 \text{ mA}$

Notes:

1. ΔV_f for diodes in pairs and quads in 15 mV maximum at 1 mA.
2. ΔC_{T0} for diodes in pairs and quads is 0.2 pF maximum.
3. Effective Carrier Lifetime (τ) for all these diodes is 100 ps maximum measured with Krakauer method at 5 mA.
4. See section titled "Quad Capacitance."
5. $R_D = R_S + 5.2\Omega$ at 25°C and $I_F = 5 \text{ mA}$.

Diode Burnout

Any Schottky junction, be it an RF diode or the gate of a MESFET, is relatively delicate and can be burned out with excessive RF power. Many crystal video receivers used in RFID (tag) applications find themselves in poorly controlled environments where high power sources may be present. Examples are the areas around airport and FAA radars, nearby ham radio operators, the vicinity of a broadcast band transmitter, etc. In such environments, the Schottky diodes of the receiver can be protected by a device known as a limiter diode.^[5] Formerly available only in radar warning receivers and other high cost electronic warfare applications, these diodes have been adapted to commercial and consumer circuits.

Avago offers a complete line of surface mountable PIN limiter diodes. Most notably, our HSMP-4820 (SOT-23) can act as a very fast (nanosecond) power-sensitive switch when placed between the antenna and the Schottky diode, shorting out the RF circuit temporarily and reflecting the excessive RF energy back out the antenna.

[5] Avago Application Note 1050, "Low Cost, Surface Mount Power Limiters."

Assembly Instructions

SOT-3x3 PCB Footprint

Recommended PCB pad layouts for the miniature SOT-3x3 (SC-70) packages are shown in Figures 26 and 27 (dimensions are in inches). These layouts provide ample allowance for package placement by automated assembly equipment without adding parasitics that could impair the performance.

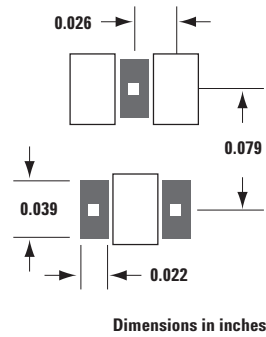

Figure 26. Recommended PCB Pad Layout for Avago's SC70 3L/SOT-323 Products.

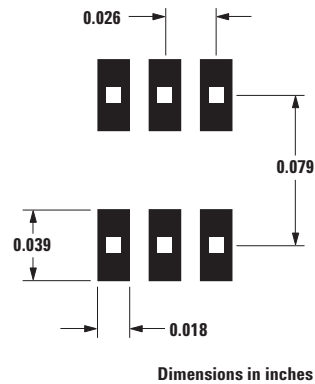
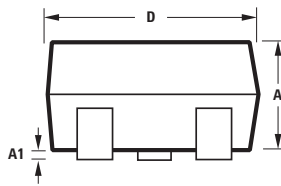
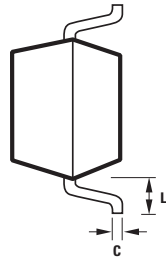
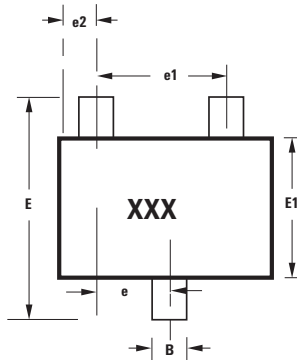

Figure 27. Recommended PCB Pad Layout for Avago's SC70 6L/SOT-363 Products.

Package Dimensions

Outline 23 (SOT-23)



SYMBOL	DIMENSIONS (mm)	
	MIN.	MAX.
A	0.79	1.20
A1	0.000	0.100
B	0.37	0.54
C	0.086	0.152
D	2.73	3.13
E1	1.15	1.50
e	0.89	1.02
e1	1.78	2.04
e2	0.45	0.60
E	2.10	2.70
L	0.45	0.69

Notes:
XXX-package marking
Drawings are not to scale

Outline SOT-323 (SC-70 3 Lead)

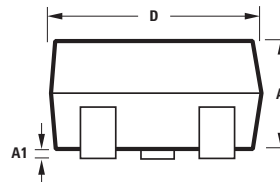
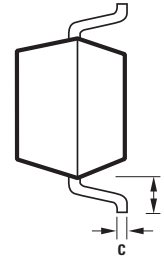
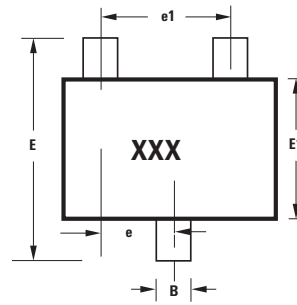

SYMBOL	DIMENSIONS (mm)	
	MIN.	MAX.
A	0.80	1.00
A1	0.00	0.10
B	0.15	0.40
C	0.10	0.20
D	1.80	2.25
E1	1.10	1.40
e	0.65 typical	
e1	1.30 typical	
E	1.80	2.40
L	0.425 typical	

Notes:
XXX-package marking
Drawings are not to scale

Outline 143 (SOT-143)

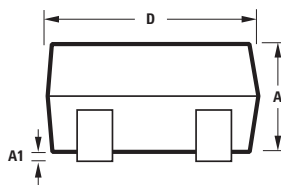
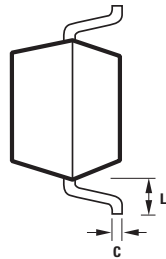
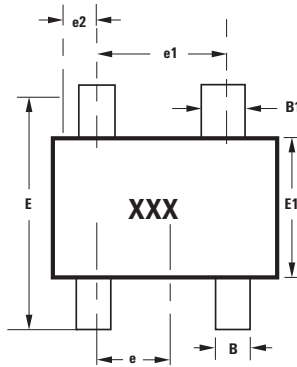

SYMBOL	DIMENSIONS (mm)	
	MIN.	MAX.
A	0.79	1.097
A1	0.013	0.10
B	0.36	0.54
B1	0.76	0.92
C	0.086	0.152
D	2.80	3.06
E1	1.20	1.40
e	0.89	1.02
e1	1.78	2.04
e2	0.45	0.60
E	2.10	2.65
L	0.45	0.69

Notes:
XXX-package marking
Drawings are not to scale

Outline SOT-363 (SC-70 6 Lead)

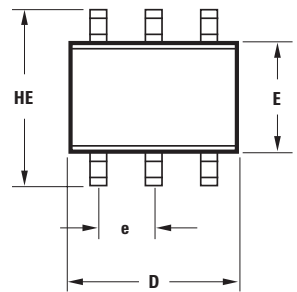

SYMBOL	DIMENSIONS (mm)	
	MIN.	MAX.
E	1.15	1.35
D	1.80	2.25
HE	1.80	2.40
A	0.80	1.10
A2	0.80	1.00
A1	0.00	0.10
Q1	0.10	0.40
e	0.650 BCS	
b	0.15	0.30
c	0.10	0.20
L	0.10	0.30

